

AIR GAOE 050

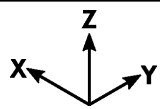

X: 0 mm
Y: 0 mm
Z: 0 mm

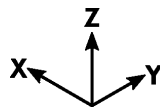

X: 500 mm
Y: 138 mm
Z: 820 mm

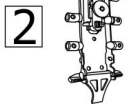
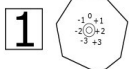
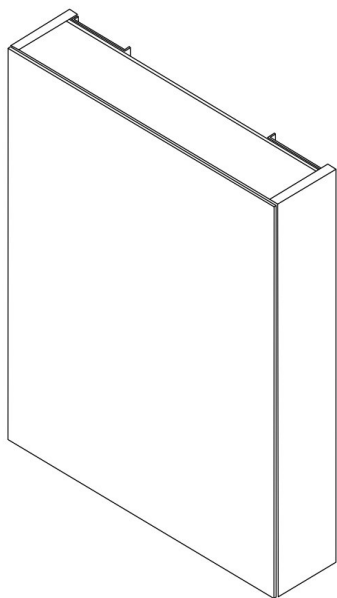

X 500 mm
Z 820 mm
A 80 mm
B 195 mm
C mm
D 1/2 Z
E 1/2 X
F 400 mm
G 300 mm
H mm
I mm
J mm

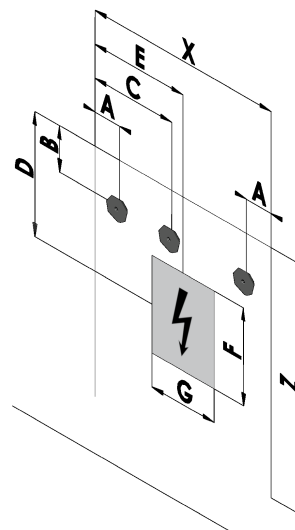

220V-240V~ ; 50Hz-60Hz ; max. 500W ; IP44 ; 4000K 

 Max. 50 Kg

